

Pump 1 (RED Receptacle)

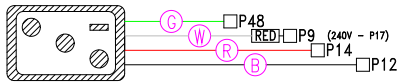

Pump 2 (PINK Receptacle)

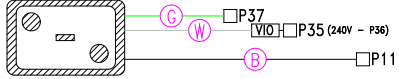

Air Blower (PURPLE Receptacle)

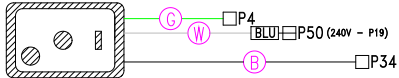

Ozone (YELLOW Receptacle)

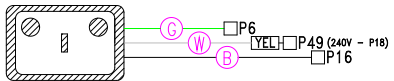

Fiber Optic (GREEN Receptacle)

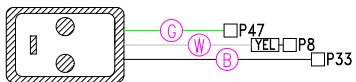

Light (WHITE 3-Pin Receptacle)

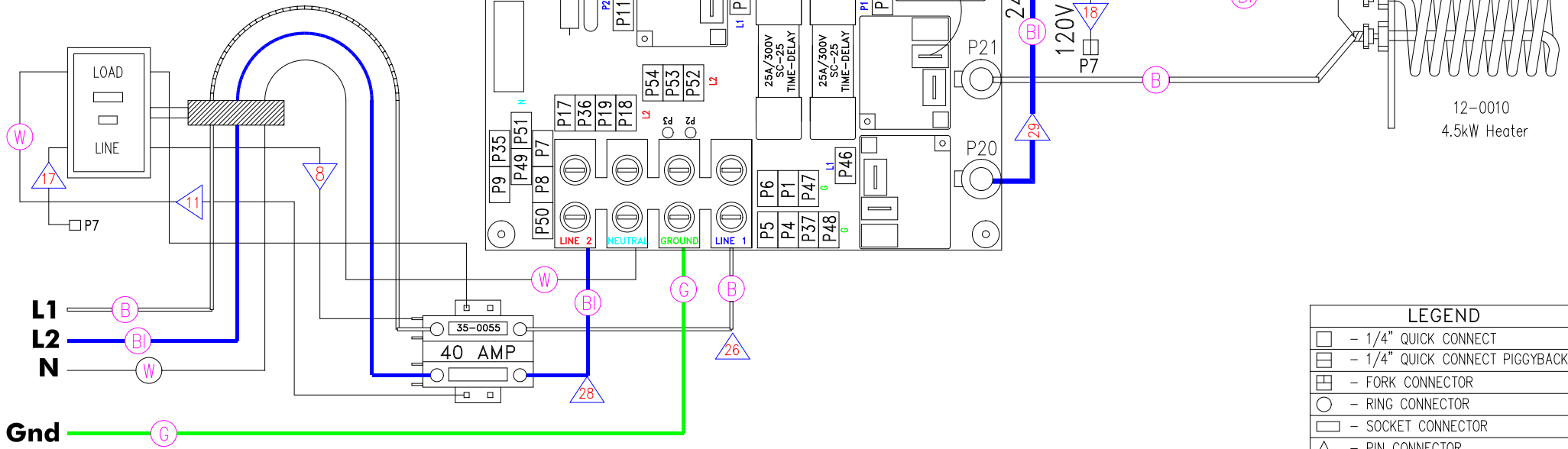
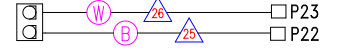

LEGEND	
	- 1/4" QUICK CONNECT
	- 1/4" QUICK CONNECT PIGGYBACK
	- FORK CONNECTOR
	- RING CONNECTOR
	- SOCKET CONNECTOR
	- PIN CONNECTOR

**HYDRO-QUIP**  
CORONA, CA (909) 273-7575

Manufacture Notes: #1 For 240V operation of heater, plug must be installed into 240V receptacle

Dwg. No. **M556AH-DKQY-ZS**

Drawn BH Rev 4

Wire Color Code

Approved By:

Date 02.14.05

B - Black G - Green  
Br - Brown Bl - Blue  
R - Red V - Violet  
O - Orange W - White  
Y - Yellow Gr - Gray

Diagram No. 8008